

YOKOGAWA 



FlowCam[®] 8000 Series

FLOW IMAGING MICROSCOPY

Highest versatility in particle imaging

Particle Analysis with Vision[®]

Flow Imaging Microscopy (FIM) combines the benefits of digital imaging, flow cytometry, and microscopy into a single solution. Beyond traditional particle sizing and counting, image-based analysis allows for comprehensive characterization of subvisible API aggregates and contaminants in biopharmaceuticals, mammalian cells, microplankton, emulsions, and advanced materials.

Through its exceptional image quality and the widest size range available, FlowCam 8000 represents state-of-the-art particle imaging technology. Analyze thousands of particles in less than a minute and comprehensively characterize the size, count, morphology, and identity of subvisible and visible particulates in their native solvent.

With applications in biopharmaceutical formulations, cell and gene therapy, oceanographic research, municipal water quality monitoring, materials science, and many other markets, FlowCam continues to re-imagine particle analysis.

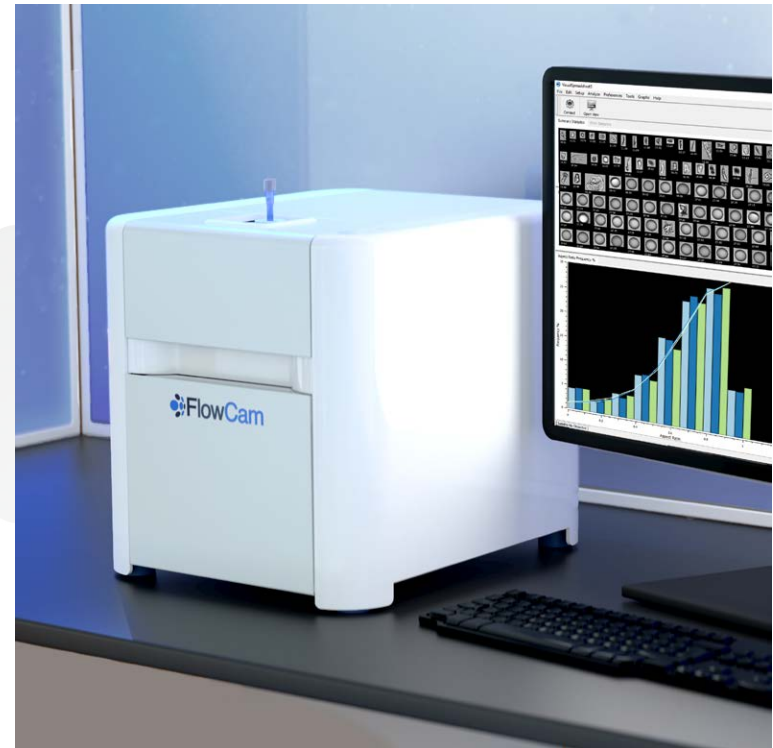

**OBTAIN
MEANINGFUL RESULTS**

Obtain statistically significant results in less than a minute, with as little as 100 μ L of sample. With advanced hardware and processing capabilities, FlowCam is streamlined for rapid data acquisition and analysis.

SORT, FILTER, QUANTIFY

Acquire data and classify images based on 40+ morphological parameters with the powerful, yet flexible VisualSpreadsheet[®] software

**AUTOMATICALLY
IDENTIFY WITH AI**

Add out-of-the-box machine learning to automatically differentiate protein aggregates in formulations with the optional VisualAI[™] software module – no user setup required.

**MAINTAIN
SAMPLE INTEGRITY**

Analyze samples in their native environment. FlowCam accommodates a wide range of aqueous and organic fluids, including high-viscosity solvents and buffers.



FlowCam

**DIFFERENTIATE
WITH FLUORESCENCE**

Enhance analysis of fluorescent samples with FlowCam 8400. Excitation options of 488 nm, 532 nm, or 633 nm assist in identifying aquatic organisms.

BE FLEXIBLE

Use FlowCam in both research and routine operations and work with a wide range of sample types and concentrations. ALH for FlowCam[™] enables unattended operations for up to 384 samples.

How it Works

Flow imaging microscopy, sometimes referred to as dynamic image analysis, is a solution-based technique to capture subvisible and visible images in a microfluidic channel under flow.

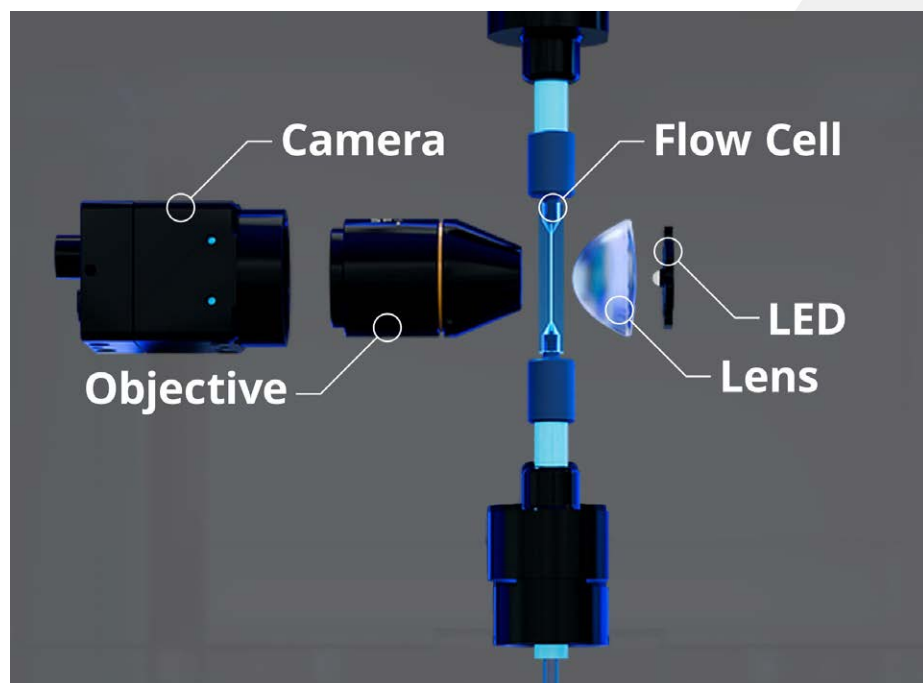

1. A sample is manually or automatically loaded into the injection port
2. A high-precision syringe draws the sample into an optical flow cell and a fluidics sensor initiates data acquisition
3. A high-speed camera records images of the full width and depth of the flow cell as the sample flows through the optical field of view
4. Particle images are segmented from the camera images and captured in real-time as they flow through the flow cell
5. Data may be further analyzed, grouped, and filtered post-acquisition

In FlowCam 8400 and FlowCam Cyano, fluorescence excitation allows FlowCam to capture particle images whenever a fluorescing object is detected in the flow cell.

FlowCam 8000 Series Models

FlowCam 8100

- Highest versatility in flow imaging microscopy
- Widest range of applications in biopharma formulations, cell and gene therapy, materials characterization, and aquatic research
- Available with color or black-and-white camera

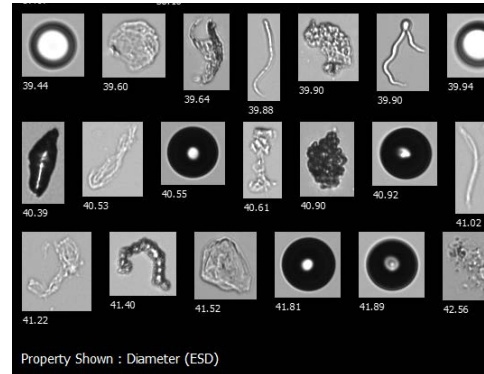

Analyze biotherapeutics with FlowCam 8100 with a black and white camera

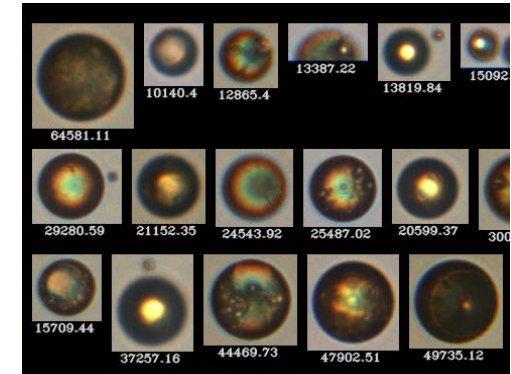

Characterize colored particles with FlowCam 8100 (pictured here: oil droplets in water)

FlowCam Cyano

- Optimized for freshwater quality monitoring
- Integrated fluorescence triggering option to detect and differentiate between images of cyanobacteria and other algae types
- Color camera, 633 nm laser excitation

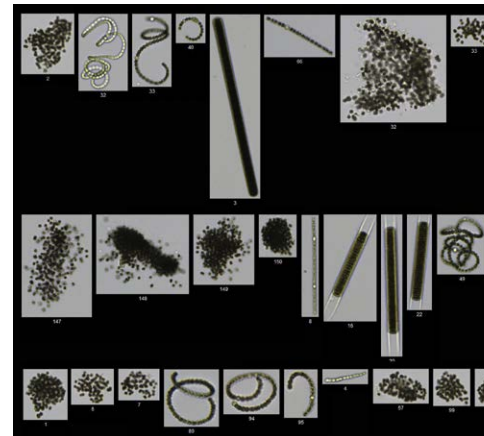

Separate cyanobacteria from diatoms and other algae with FlowCam Cyano

FlowCam 8400

- Differentiate specific analytes through fluorescence triggering
- Applications include marine and freshwater research as well as water quality monitoring
- Color camera, 488 nm or 532 nm laser excitation

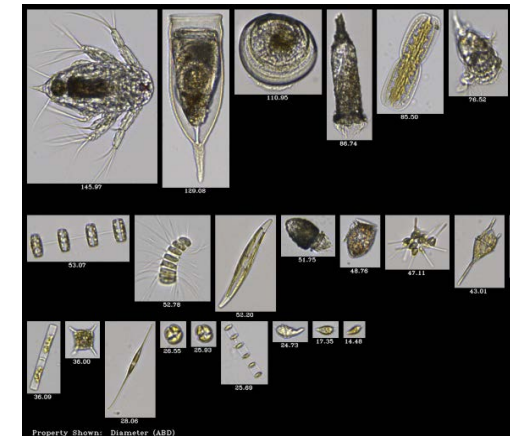

Perform viability studies with FlowCam 8400

VisualSpreadsheet Software



Turning Data into Insight

VisualSpreadsheet is a powerful, all-in-one software program capable of setting up methods, acquiring data, and processing images captured with FlowCam.

Analyze, sort, filter, group, and classify images based on 40+ morphology parameters and their combinations, or use the “Find Similar” function in the software to identify what is in your sample. Group data from multiple runs or samples for easy comparison.

VisualSpreadsheet offers an optional 21 CFR Part 11 compliance package.

VisualAI™



Beyond Morphological Parameters

VisualAI, an optional Artificial Intelligence module, is an instrument- and sample-agnostic tool to automatically classify particles in a biotherapeutic formulation.

Identify protein aggregates and silicone oil droplets and differentiate them from other contaminants directly within VisualSpreadsheet 6 – using out-of-the-box VisualAI software.

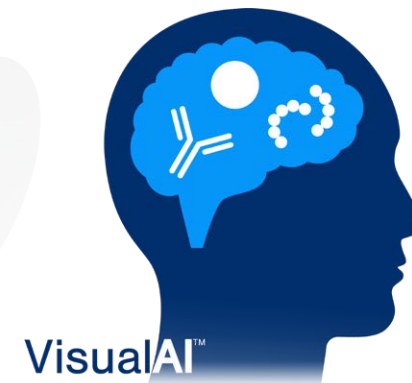
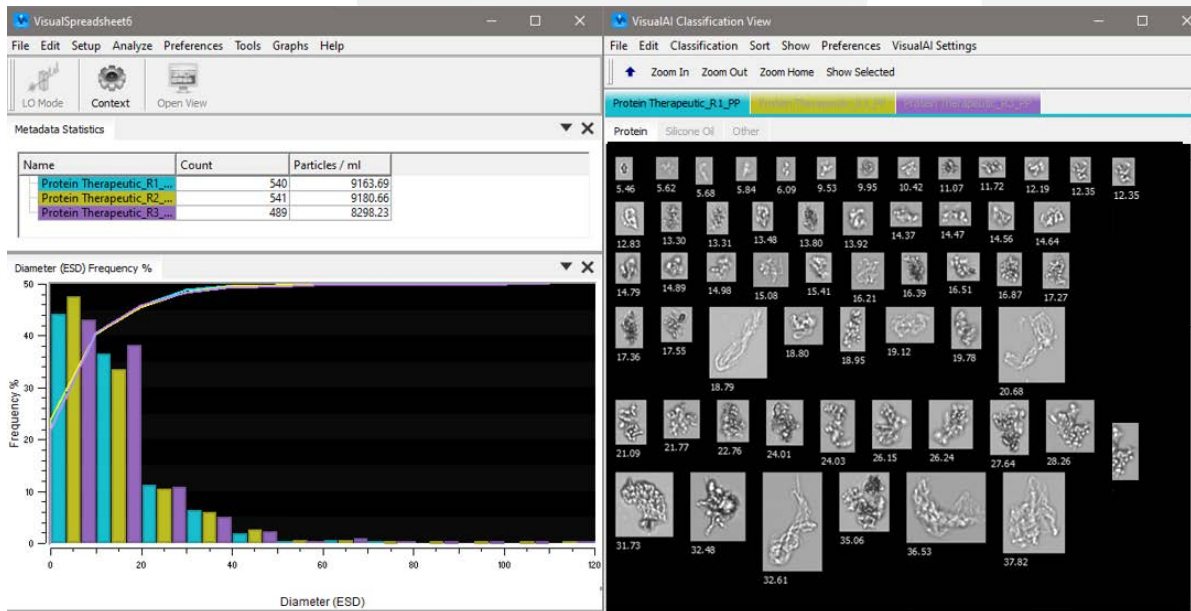

Automated Liquid Handling

ALH for FlowCam™ seamlessly integrates with FlowCam 8000 Series instruments, FlowCam LO, and FlowCam Cyano to enable automated sample preparation and analysis. Improve lab productivity, analysis repeatability, and data quality of flow imaging microscopy with state-of-the-art robotic handling.

ALH for FlowCam benefits:

- Unattended flow imaging microscopy for up to 384 samples
- Higher productivity and improved data reproducibility
- A configurable sample deck for flexible sample queuing and preparation
- Powerful, easy-to-use software with integrated data acquisition in VisualSpreadsheet
- HEPA-filtered sample enclosure for cleaner sample handling
- All-inclusive system installation and support



World-Class Customer Service

Our customer service team is available to help with all things FlowCam, including:



- Technical Support
- Remote and On-Site Training
- Application Support
- IQ/OQ Services
- Preventative Maintenance
- Repairs and Upgrades

Maximize your FlowCam utilization with a full training package led by our experts – customized for your application. This hands-on, in-depth training provides a thorough understanding of flow imaging microscopy. Learn from our scientists how to run and analyze samples, and get a wealth of tips and tricks to get the most out of your instrument.

Every new instrument includes a one-year warranty, unlimited email and phone support, and one year of free access to FlowCam University training.

For continuous support we offer Gold or Silver service plans that include annual preventative maintenance services, software upgrades, access to virtual training, personalized remote support, and other benefits.



Biopharmaceutical Development

Flow Imaging Microscopy is a recommended orthogonal method to Light Obscuration for determining subvisible particulate content per USP <1788>. FlowCam is widely used in biotherapeutics research, formulation, and development for proteins, nano-drug delivery systems, and cell and gene therapy products.



Materials Characterization

FlowCam is employed in a wide variety of materials and chemicals-focused applications: from the characterization of food and beverage ingredients to printer toner and superabrasives, ion exchange resins, column packing material, fibers, additive manufacturing, polymer composition analysis, chemicals, cosmetics formulations, and microencapsulation processes.



Marine and Freshwater Research

For more than 20 years, scientists have been using FlowCam as an automated, fast and accurate, easy-to-use alternative to manual microscopy to monitor plankton community composition. FlowCam has become a valued instrument worldwide for studying marine and freshwater microorganisms.



Water Quality Monitoring and Environmental

FlowCam provides a proactive, cost-effective, and scalable solution to monitor raw and treated water. Water utilities around the world use FlowCam to detect and quantify populations of taste and odor producers, filter-fouling diatoms, and potentially toxic cyanobacteria. Environmental applications include monitoring soil microorganisms, pollen, seeds, and pollutants.



Biopharmaceutical Development

- Detection and measurement of cells, API aggregates, and other particles
- Formulation research and development
- QC diagnostics and lot release testing
- Stability studies and shelf life estimation
- Purification process development
- Excipient and API characterization

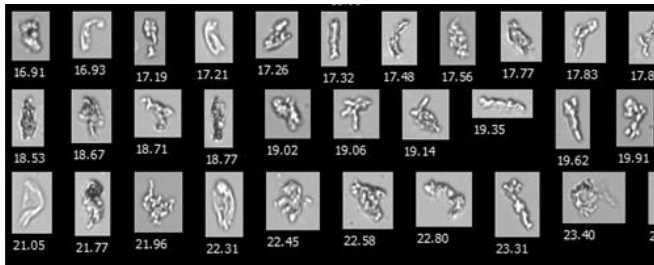

Protein aggregates

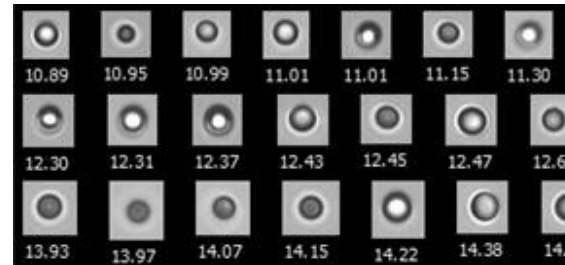

Silicone oil droplets

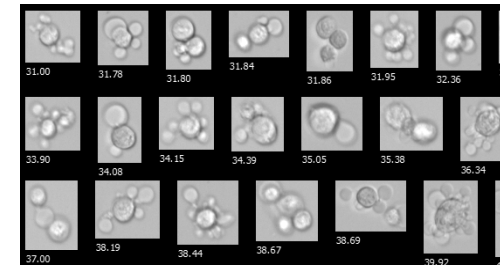

Cell aggregates



Materials Characterization

- Abrasives
- Wood and pulp fibers
- Cosmetics and fragrances
- Food and beverage
- Microencapsulation
- Oil and gas
- Paints and polymers
- Printer toner
- Washwater

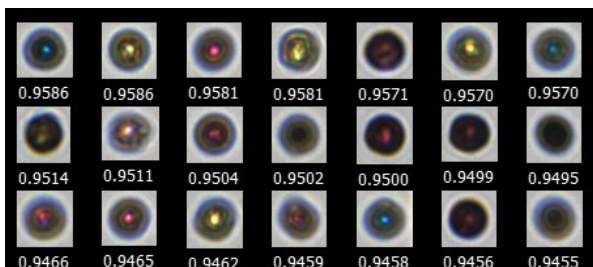

Color printer toner particles

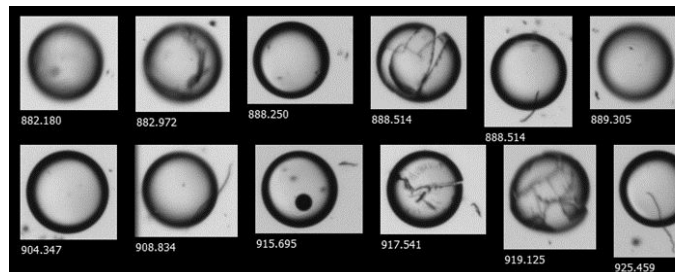

Polystyrene spheres

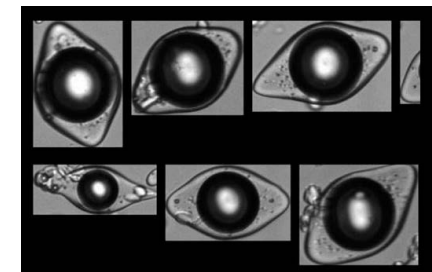

Microencapsulated flavor particles



Marine and Freshwater Research

- Identify and enumerate phytoplankton and zooplankton
- Investigate harmful algal blooms (HABs)
- Support health of aquaculture systems
- Observe microalgae cultures
- Analyze sediment particles

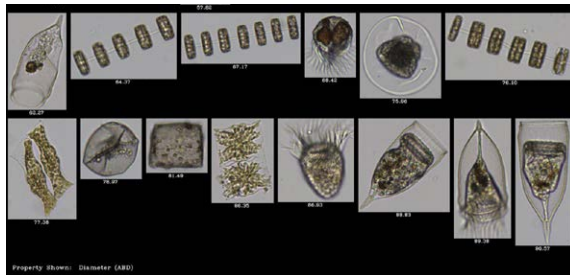

Marine plankton

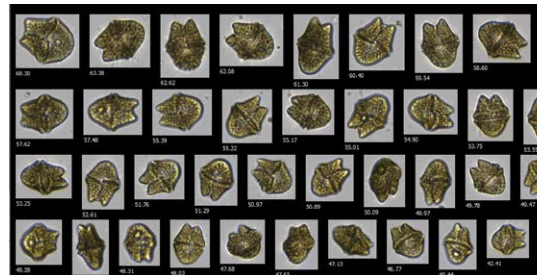

Akashiwo sanguinea (harmful algal bloom)

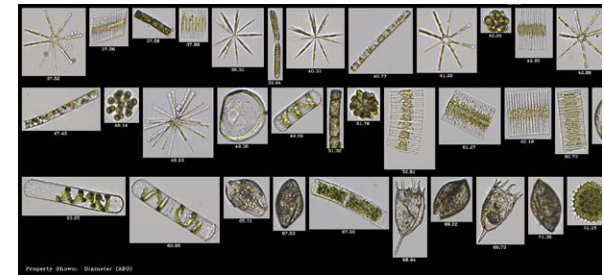

Freshwater plankton



Water Quality Monitoring and Environmental

- Identify cyanobacteria, taste and odor, and other nuisance algae in drinking source water
- Use data to inform water treatment decisions
- Monitor filter performance
- Detect and monitor soil microbes, mites, forest litter invertebrates, and nematodes
- Determine seed viability
- Analyze pollen particles

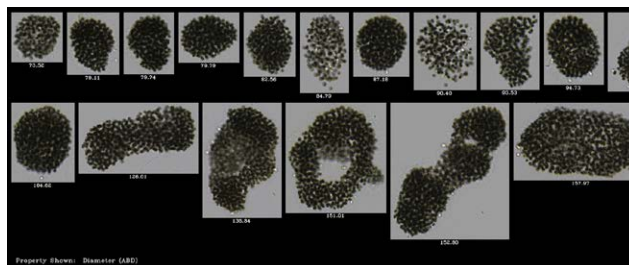

Microcystis (cyanobacteria)

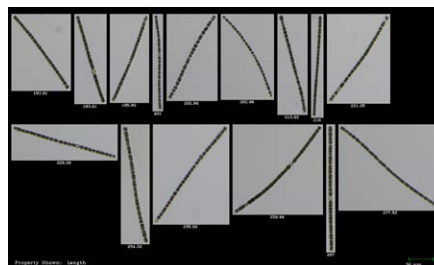

Dolichospermum (cyanobacteria)

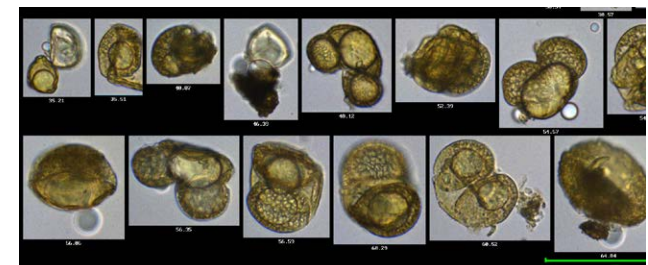

Pollen grains

Specifications

PARTICLE SIZE RANGE	2 µm to 1 mm
MAGNIFICATION & FLOW CELLS	20X (~200X magnification), flow cell: 50 µm FOV 10X (~100X magnification), flow cell: 80 µm FOV or 100 µm FOV 4X (~40X magnification), flow cell: 300 µm FOV or 600 µm FOV 2X (~20X magnification), flow cell: 1 mm FOV
MINIMUM SAMPLE VOLUME	100 µL
SAMPLE PROCESSING CAPABILITY	0.05 mL/minute at 20X and up to 10 mL/minute at 2X
FLUIDICS	Micro-syringe pump with multiple sizes to optimize flow rates: 0.5 mL, 1 mL, 2.5 mL, 5 mL, 12.5 mL
MAXIMUM PARTICLE CONCENTRATION	5 million particles/mL at 2.5 µm particle size
DATA ACQUISITION METHOD	FlowCam 8100: auto-imaging, FlowCam Cyano and FlowCam 8400: fluorescence-based laser triggering and auto-imaging
CAMERA	High resolution (1920 x 1200 pixels) CMOS. Monochrome and color available.
FRAME RATE	Shutter speed up to 100 frames per second
FOCUS METHOD	Automatic
MEASURED PARAMETERS	<p>Basic Shape Parameters: Area, Aspect Ratio (width/length), Diameter (Spherical and Area-Based), Length, Volume (ABD-based), Volume (ESD-based), Width, 3 Biovolume Measurements</p> <p>Advanced Morphology Parameters: Area (Filled), Circle Fit, Circularity, Circularity (Hu), Compactness, Convex Perimeter, Convexity, Elongation, Fiber Curl, Fiber Straightness, Geodesic Aspect Ratio, Geodesic Length, Geodesic Thickness, Perimeter, Roughness, Symmetry</p> <p>Grayscale and Color Measurements: Average Blue, Average Green, Average Red, Blue/Green Ratio, Red/Blue Ratio, Red/Green Ratio, Edge Gradient, Intensity, Sigma Intensity, Sum Intensity, Transparency</p>
AUTOMATION	Compatible with ALH for FlowCam automated liquid handler
SOFTWARE OPTIONS	21 CFR Part 11 compliance module, VisualAI tool to automatically ID protein aggregates and silicone oil droplets
DIMENSIONS & WEIGHT	36 cm wide x 43 cm deep x 38 cm tall, 27 kg (43 kg shipping weight)
POWER REQUIREMENTS	FlowCam 8100: 92 watt maximum, FlowCam Cyano and FlowCam 8400: 115 watt maximum

Specifications are subject to change without notice

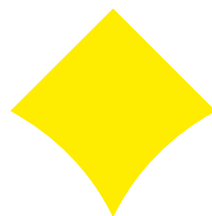

YOKOGAWA

Yokogawa Fluid Imaging Technologies

Yokogawa Fluid Imaging Technologies manufactures industry-leading particle analysis instrumentation based on digital imaging technology. Our flagship product, FlowCam, is the first automated particle analysis instrument to use digital imaging for measuring size and shape of microscopic particles in a fluid medium. FlowCam has been deployed in over 50 countries, supporting research, development, and environmental monitoring in the life sciences, materials research, and industrial applications.



| Yokogawa Fluid Imaging Technologies, Inc. | www.flowcam.com | +1-207-289-3200